





# QUICK START

## DÉMARRAGE RAPIDE



## SCHNELLSTART

Model B	2
Model C	6
Model C Beehive / Ruche / Bienenstock	10
Performance GSM	14
Endurance	17
Mini	22
OBD	26
Power	29

# Model B

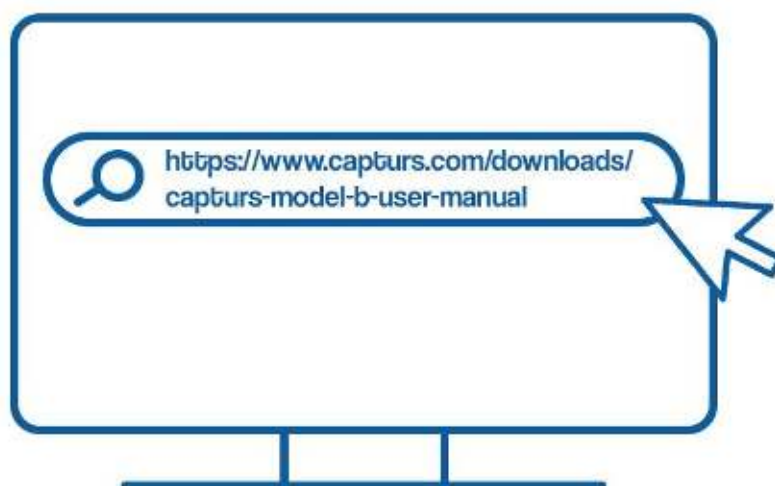
- 1)  Read the [manual](#).  
 Lire le [manuel](#).  
 Lesen Sie das [Handbuch](#).



- 2)  Charge the tracker using the micro-USB cable provided.  
 Chargez le traceur en utilisant le câble micro-USB fourni.  
 Laden Sie den Tracker mit dem mitgelieferten Micro-USB-Kabel auf.

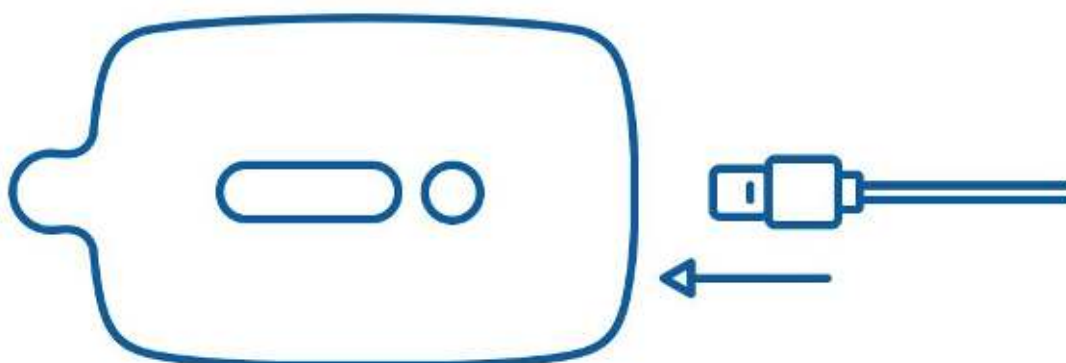

3)  Activate the tracker on [connect.capturs-systems.com](https://connect.capturs-systems.com) in the “Devices > My Devices” section.

 Activez le traceur sur [connect.capturs-systems.com](https://connect.capturs-systems.com) dans la rubrique “Balises > Mes Balises”.

 Aktivieren Sie den Tracker auf [connect.capturs-systems.com](https://connect.capturs-systems.com) im Bereich “Geräte > Meine Geräte”.

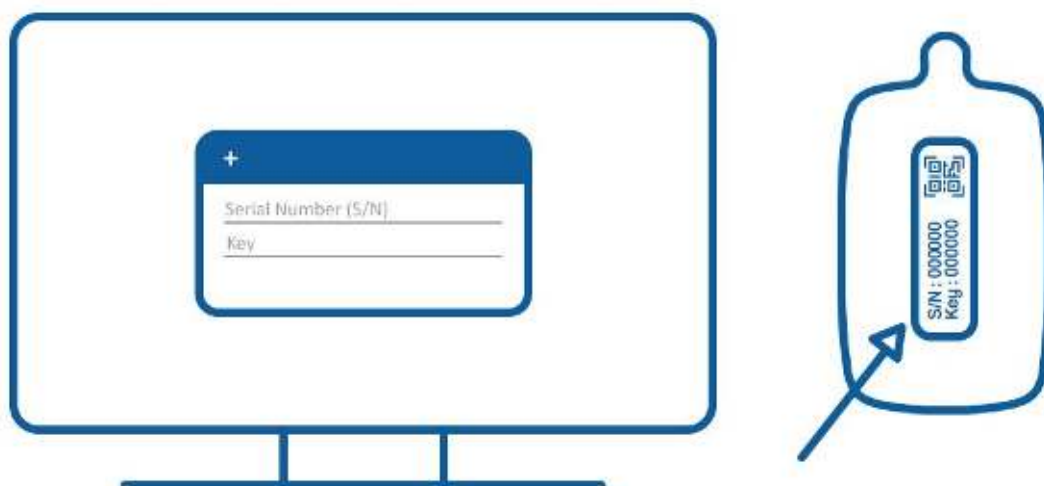



4)  Turn on the tracker by pressing the button.

 Allumez le traceur en appuyant sur le bouton.

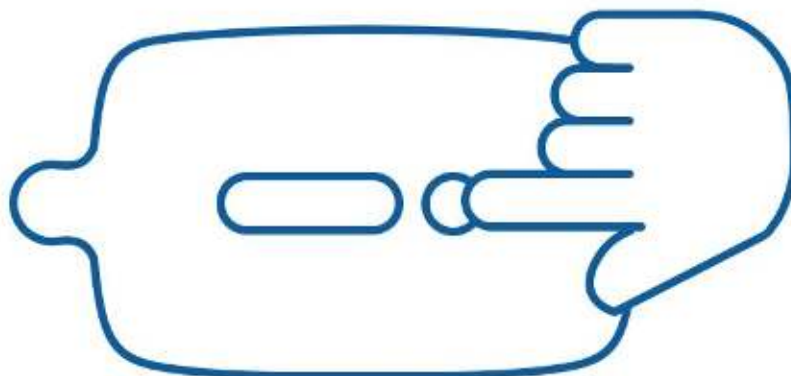
 Schalten Sie den Tracker ein, indem Sie den Knopf drücken.





5)  The tracker is switched on when the green LED appears and the blue LED flashes once ([more about the flashing LEDs](#)).

 Le traceur est allumé lorsque la LED verte apparaît et que la LED bleue clignote une fois ([en savoir plus sur le clignotement des LEDs](#)).

 Der Tracker ist eingeschaltet, wenn die grüne LED erscheint und die blaue LED einmal blinkt ([mehr über das Blinken der LEDs](#)).

# Model C

- 1)  Read the [manual](#).  
 Lire le [manuel](#).  
 Lesen Sie das [Handbuch](#).

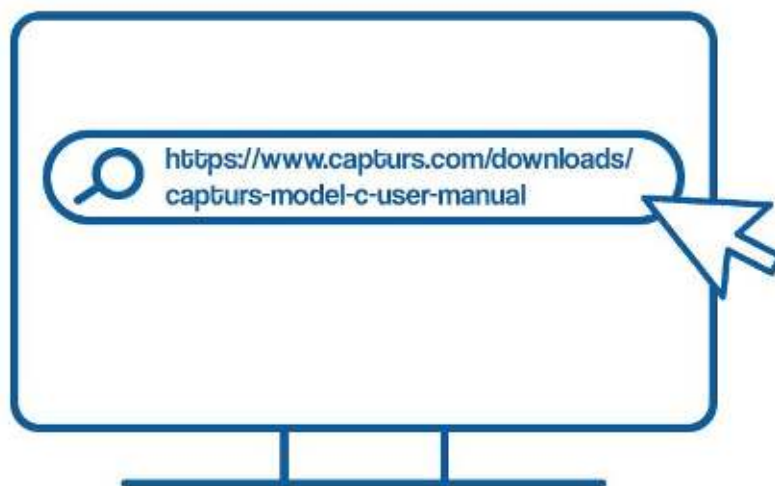



- 2)  Activate the tracker on [connect.capturs-systems.com](https://connect.capturs-systems.com) in the “Devices > My Devices” section.

 Activez le traceur sur [connect.capturs-systems.com](https://connect.capturs-systems.com) dans la rubrique “Balises > Mes Balises”.

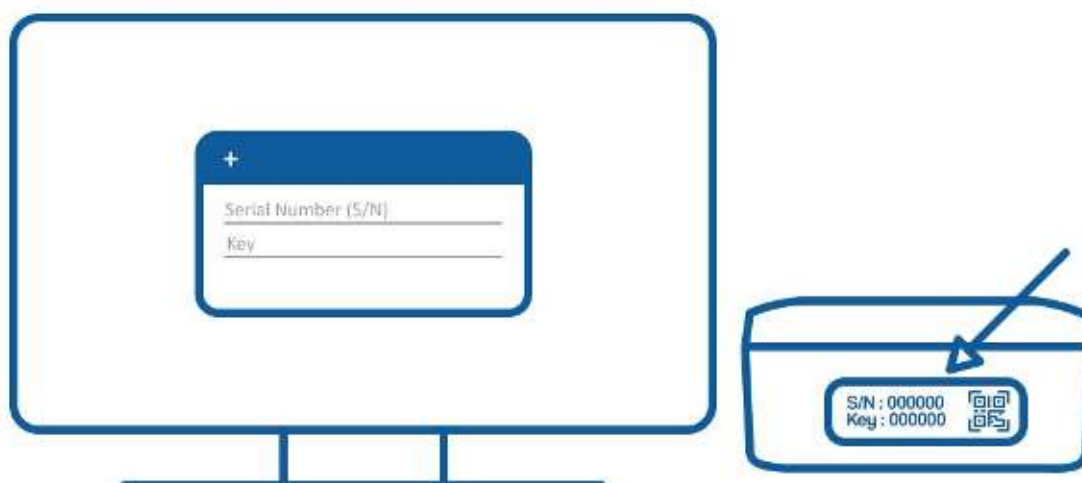
 Aktivieren Sie den Tracker auf [connect.capturs-systems.com](https://connect.capturs-systems.com) im Bereich “Geräte > Meine Geräte”.



- 3)  Unscrew the 4 screws.  
 Dévissez les 4 vis.  
 Lösen Sie die 4 Schrauben.

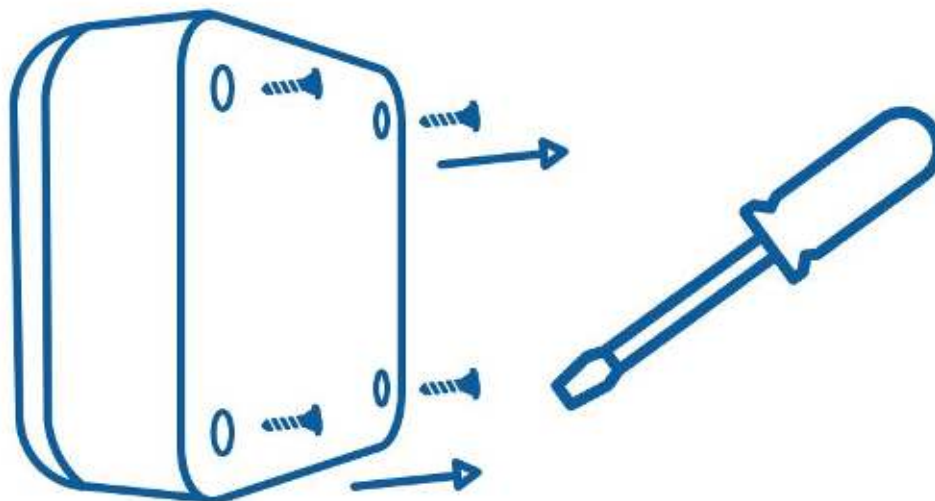



- 4)  Pull the tab and check the battery is correctly in its enclosure.

 Retirez la languette et vérifiez que la pile est bien en place dans son logement.

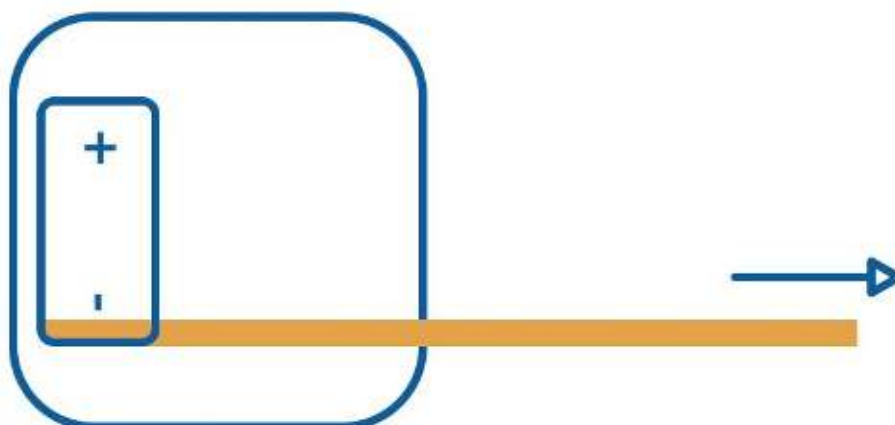
 Ziehen Sie an der Lasche und prüfen Sie, ob die Batterie richtig in ihrem Gehäuse sitzt.





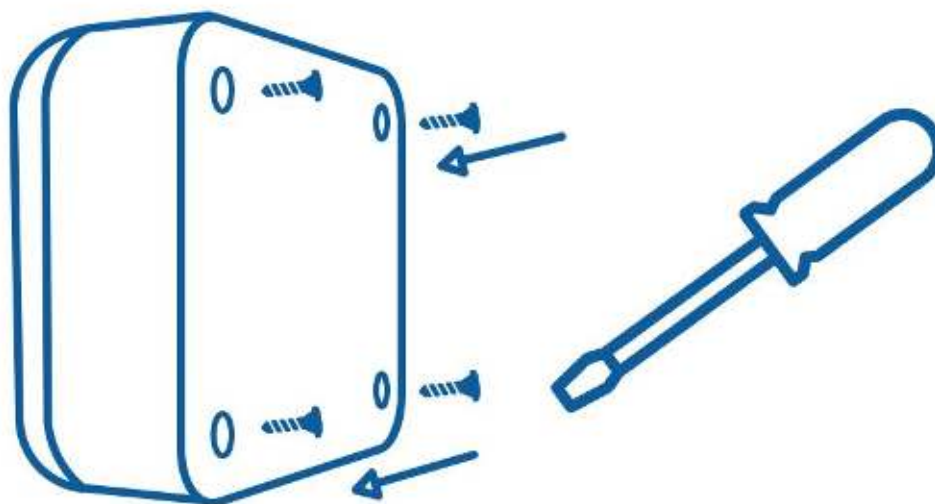

- 5)  Slightly tighten the 4 screws.  
 Révissez doucement les 4 vis.  
 Ziehen Sie die 4 Schrauben leicht heraus





# Model C

## Beehive / Ruche / Bienenstock

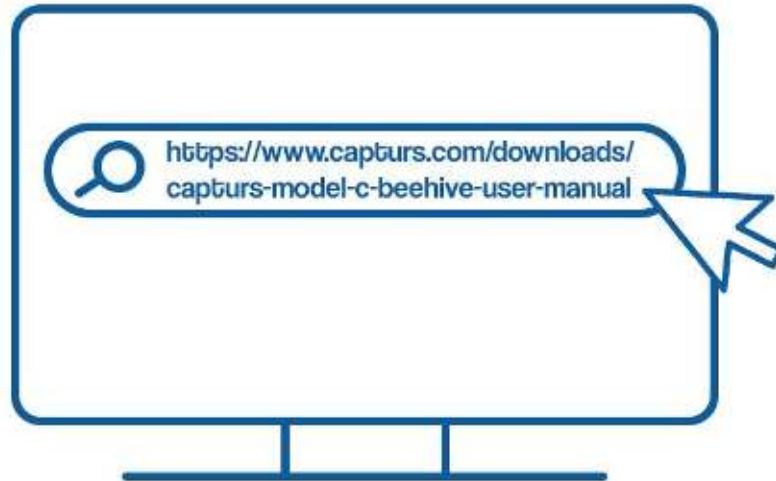
- 1)  Read the [manual](#).  
 Lire le [manuel](#).  
 Lesen Sie das [Handbuch](#).





- 2)  Activate the tracker on [connect.capturs-systems.com](https://connect.capturs-systems.com) in the "Devices > My Devices" section.

 Activez le traceur sur [connect.capturs-systems.com](https://connect.capturs-systems.com) dans la rubrique "Balises > Mes Balises".

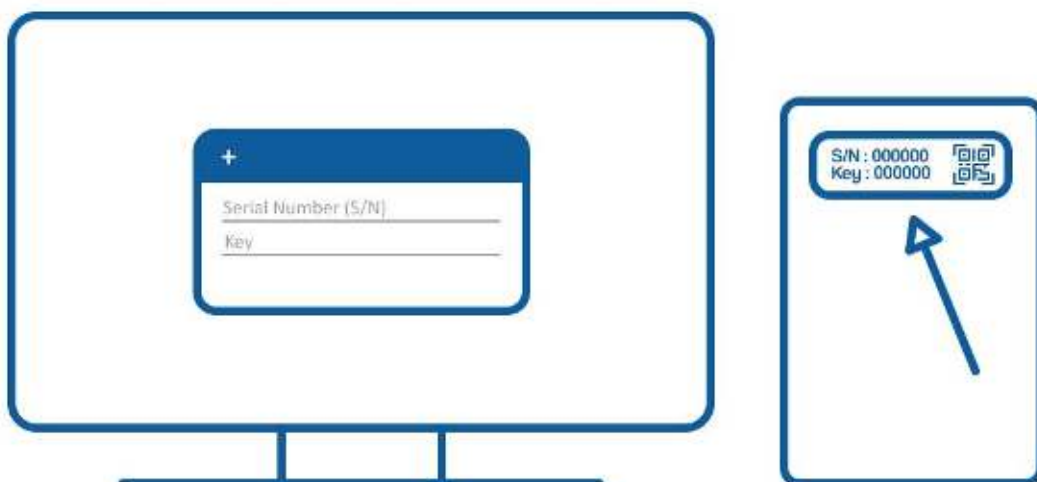
 Aktivieren Sie den Tracker auf [connect.capturs-systems.com](https://connect.capturs-systems.com) im Bereich "Geräte > Meine Geräte".



- 3)  Open the tracker.  
 Ouvrez le traceur.  
 Öffnen Sie den Tracker

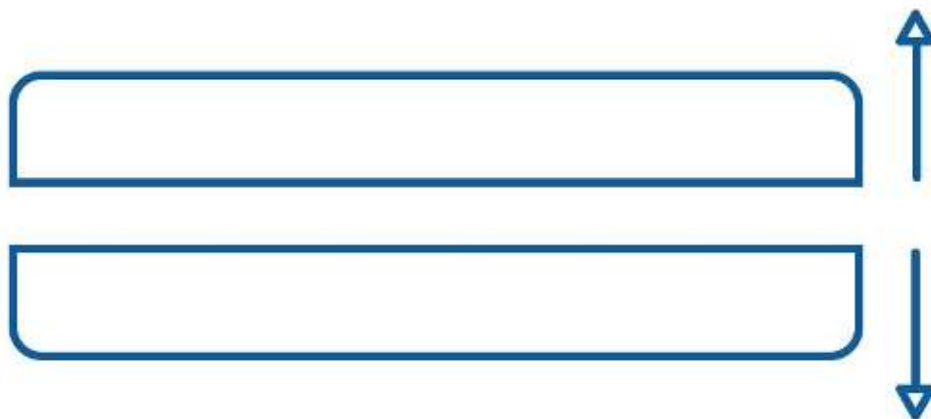



- 4)  Pull the tab and check the battery is correctly in its enclosure.

 Retirez la languette et vérifiez que la pile est bien en place dans son logement.

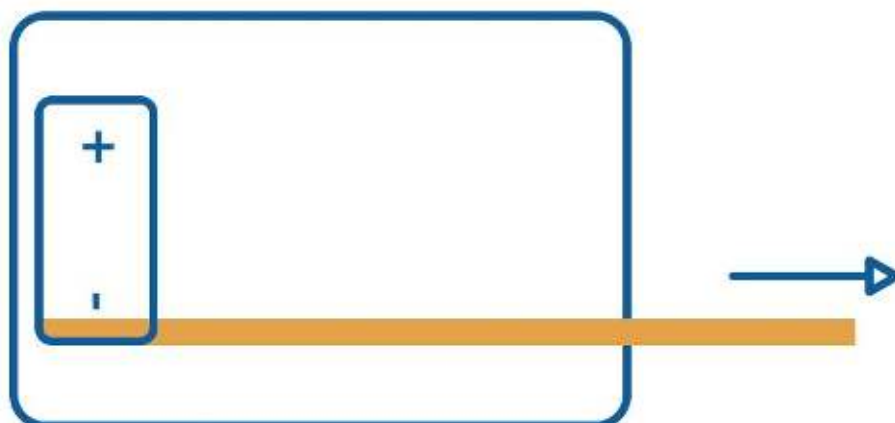

 Ziehen Sie an der Lasche und prüfen Sie, ob die Batterie richtig in ihrem Gehäuse sitzt.



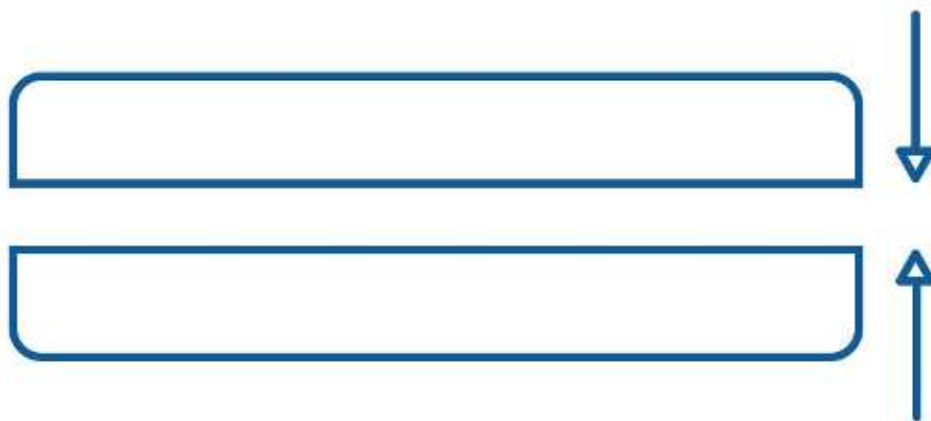

- 5)  Close the tracker.  
 Fermez le traceur.  
 Schließen Sie den Tracker



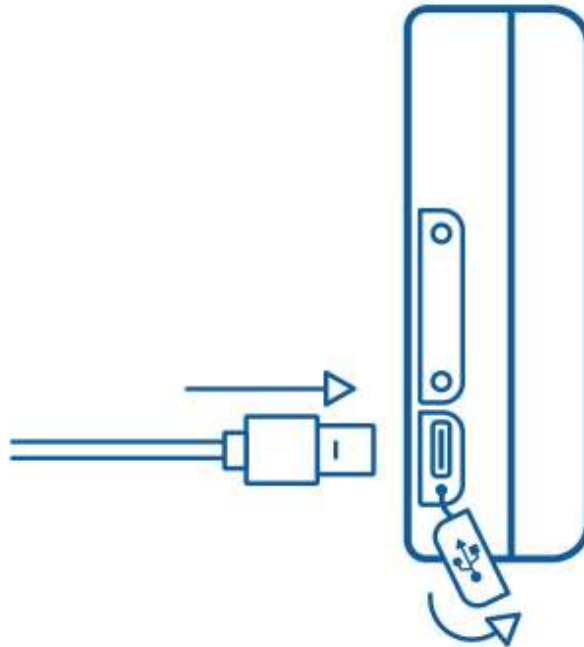

# Performance GSM

- 1)  Charge the tracker using the USB Type-C cable provided.  
 Chargez le traceur en utilisant le câble USB Type-C fourni.  
 Laden Sie den Tracker mit dem mitgelieferten USB-Typ-C-Kabel auf.





- 2)  Activate the tracker on [connect.capturs-systems.com](https://connect.capturs-systems.com) in the “Devices > My Devices” section.

 Activez le traceur sur [connect.capturs-systems.com](https://connect.capturs-systems.com) dans la rubrique “Balises > Mes Balises”.

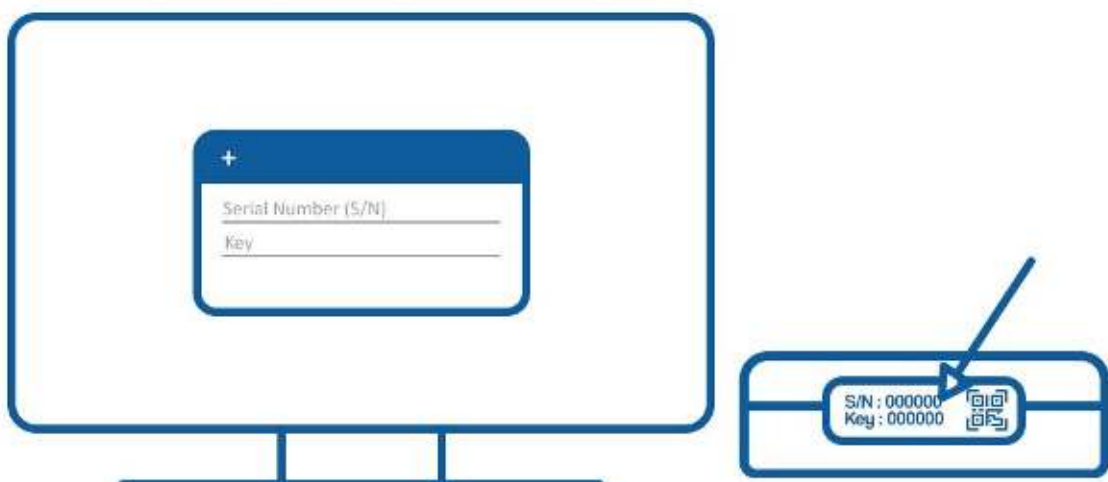
 Aktivieren Sie den Tracker auf [connect.capturs-systems.com](https://connect.capturs-systems.com) im Bereich “Geräte > Meine Geräte”.



- 3)  Turn on the tracker by pressing the button for 3 seconds.  
 Allumez le traceur en appuyant 3 secondes sur le bouton.  
 Schalten Sie den Tracker ein, indem Sie die Taste 3 Sekunden lang gedrückt halten.



- 4)  The tracker is switched on when the PWR LED lights up ([more about the flashing LEDs](#)).

 Le traceur est allumé lorsque la LED PWR s'allume ([en savoir plus sur le clignotement des LEDs](#)).

 Der Tracker ist eingeschaltet, wenn die PWR-LED leuchtet ([mehr über das Blinken der LEDs](#)).



# Endurance

# GSM

1)  Activate the tracker on [connect.capturs-systems.com](https://connect.capturs-systems.com) in the “Devices > My Devices” section.

 Activez le traceur sur [connect.capturs-systems.com](https://connect.capturs-systems.com) dans la rubrique “Balises > Mes Balises”.

 Aktivieren Sie den Tracker auf [connect.capturs-systems.com](https://connect.capturs-systems.com) im Bereich “Geräte > Meine Geräte”.

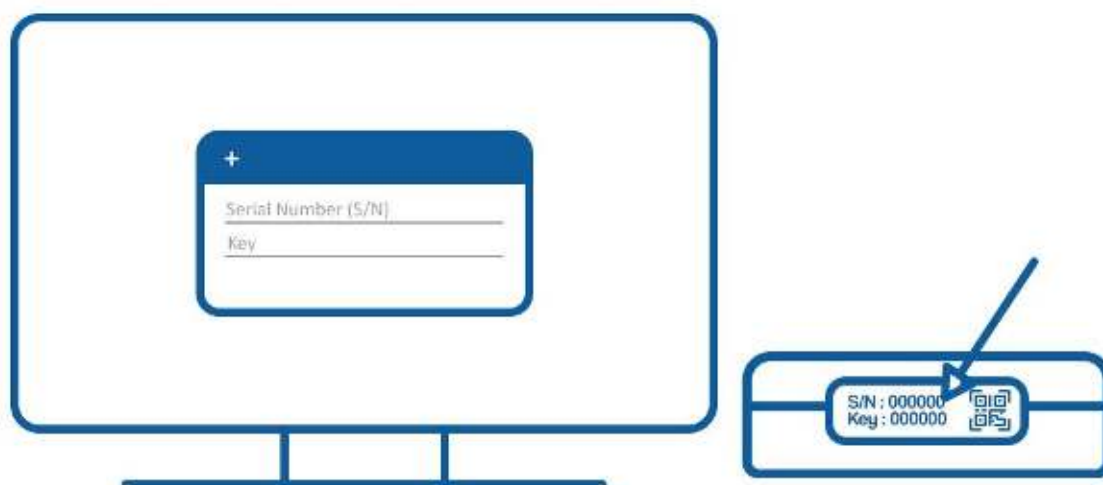



2)  Open the tracker.

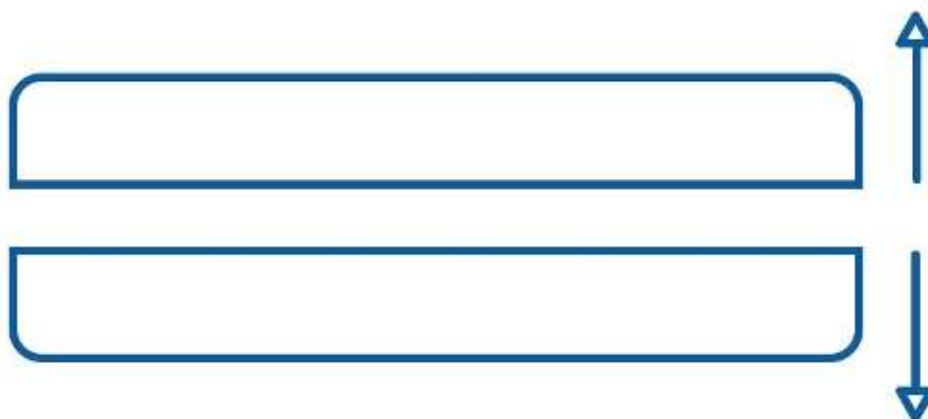

 Ouvrez le traceur.

 Öffnen Sie den Tracker



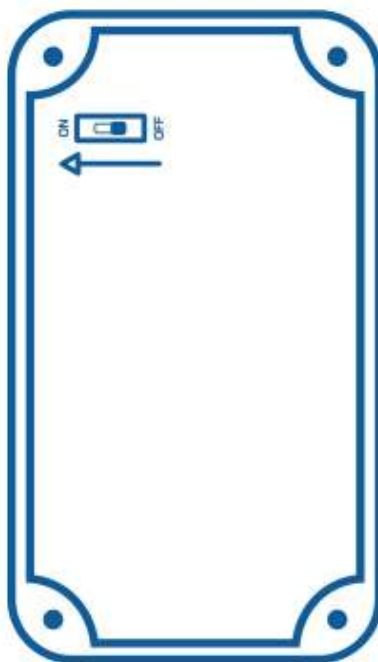

- 3)  Turn on the tracker by pushing the "ON" button.  
 Allumez le traceur en poussant le bouton sur "ON".  
 Schalten Sie den GPS-Tracker ein, indem Sie den Knopf auf "ON" drücken.

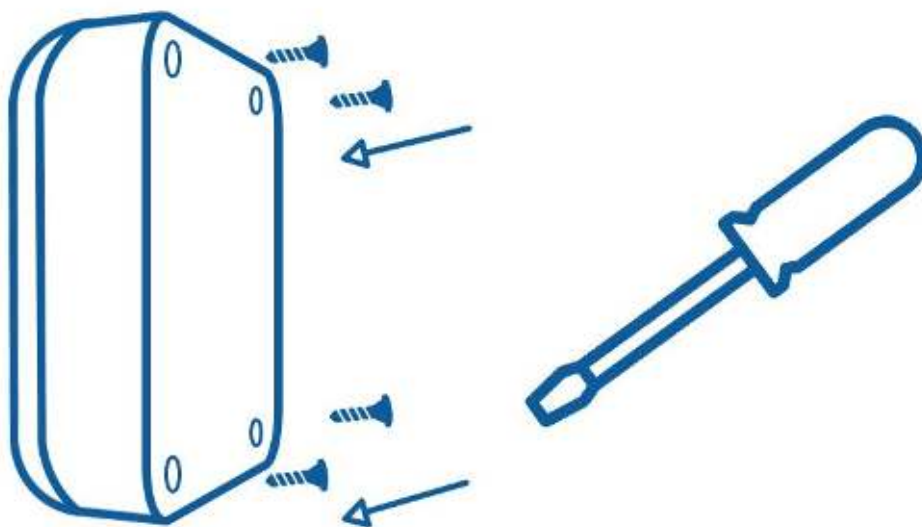

- 4)  Close the tracker and slightly tighten the 4 screws.  
 Fermez le traceur et revissez doucement les 4 vis.  
 Schließen Sie den Tracker und ziehen Sie die 4 Schrauben leicht an.



5)  The tracker is switched on when the LEDs light up ([more about the flashing LEDs](#)).

 Le traceur est allumé lorsque les LEDs s'allument ([en savoir plus sur le clignotement des LEDs](#)).

 Der Tracker ist eingeschaltet, wenn die LEDs aufleuchten ([mehr über das Blinken der LEDs](#)).





# Mini

5)  Activate the tracker on [connect.capturs-systems.com](https://connect.capturs-systems.com) in the “Devices > My Devices” section.

 Activez le traceur sur [connect.capturs-systems.com](https://connect.capturs-systems.com) dans la rubrique “Balises > Mes Balises”.

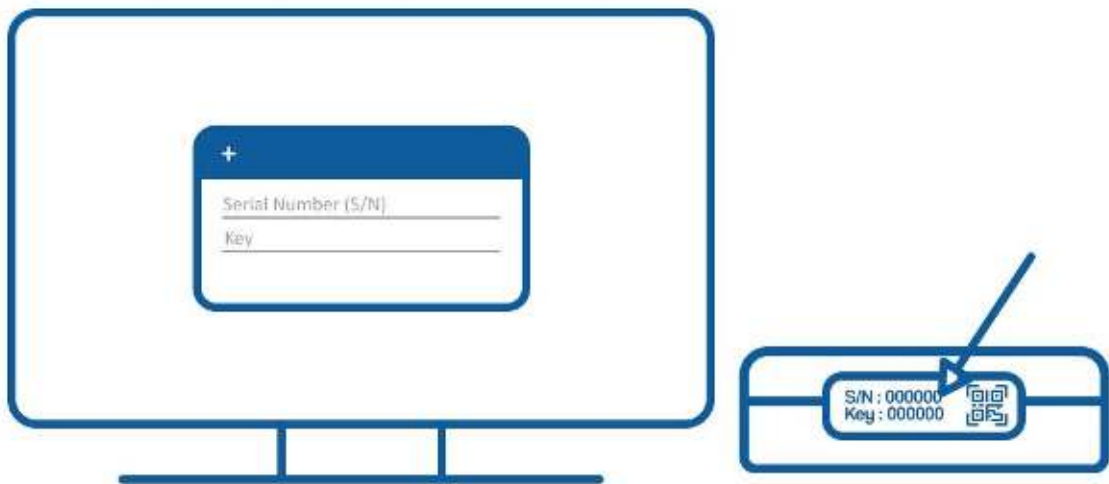
 Aktivieren Sie den Tracker auf [connect.capturs-systems.com](https://connect.capturs-systems.com) im Bereich “Geräte > Meine Geräte”.





6)  Open the tracker.

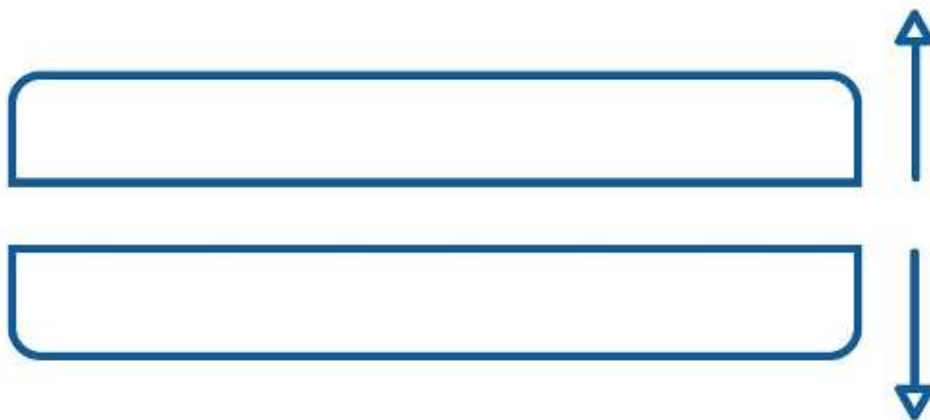

 Ouvrez le traceur.

 Öffnen Sie den Tracker



- 7)  Turn on the tracker by pushing the "ON" button.  
 Allumez le traceur en poussant le bouton sur "ON".  
 Schalten Sie den GPS-Tracker ein, indem Sie den Knopf auf "ON" drücken.



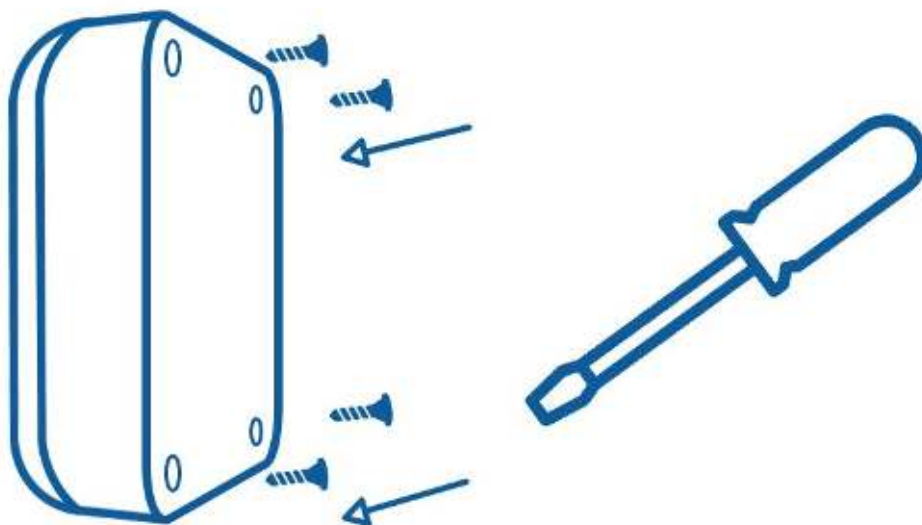

- 8)  Close the tracker and slightly tighten the 4 screws.  
 Fermez le traceur et revissez doucement les 4 vis.  
 Schließen Sie den Tracker und ziehen Sie die 4 Schrauben leicht an.







6)  The tracker is switched on when the LEDs light up ([more about the flashing LEDs](#)).

 Le traceur est allumé lorsque les LEDs s'allument ([en savoir plus sur le clignotement des LEDs](#)).

 Der Tracker ist eingeschaltet, wenn die LEDs aufleuchten ([mehr über das Blinken der LEDs](#)).

**OBD**

- 1)  Activate the tracker on [connect.capturs-systems.com](https://connect.capturs-systems.com) in the “Devices > My Devices” section.

 Activez le traceur sur [connect.capturs-systems.com](https://connect.capturs-systems.com) dans la rubrique “Balises > Mes Balises”.

 Aktivieren Sie den Tracker auf [connect.capturs-systems.com](https://connect.capturs-systems.com) im Bereich “Geräte > Meine Geräte”.

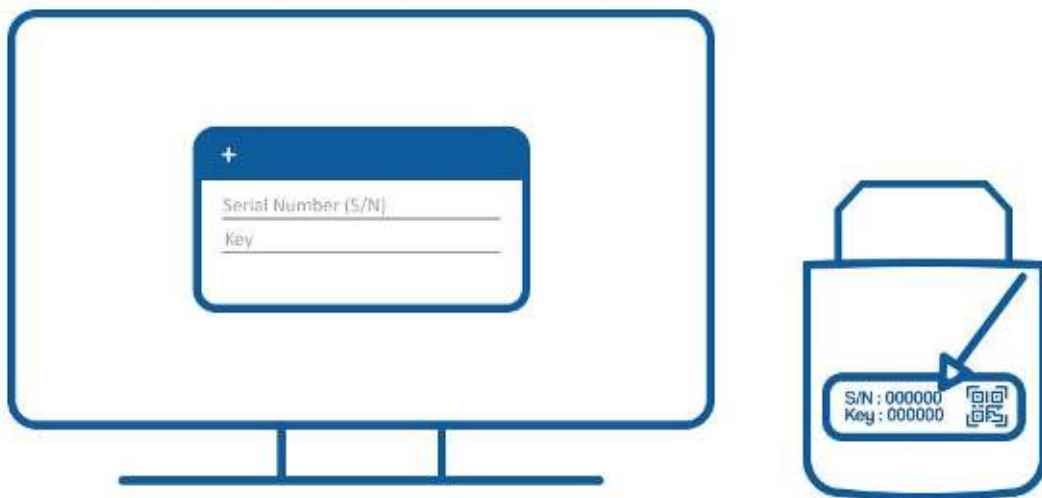



- 2)  Connect the tracker to your vehicle's OBD 2 socket.

 Branchez le traceur sur la prise OBD 2 de votre véhicule.

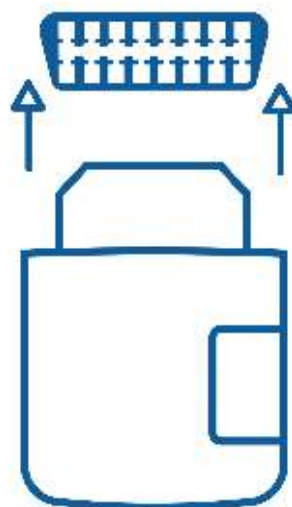
 Schließen Sie den Tracker an die OBD-2-Buchse Ihres Fahrzeugs an.





3)  The tracker is switched on when the LEDs light up ([more about the flashing LEDs](#)).

 Le traceur est allumé lorsque les LEDs s'allument ([en savoir plus sur le clignotement des LEDs](#)).

 Der Tracker ist eingeschaltet, wenn die LEDs aufleuchten ([mehr über das Blinken der LEDs](#)).

# Power

1)  Activate the tracker on [connect.capturs-systems.com](https://connect.capturs-systems.com) in the “Devices > My Devices” section.

 Activez le traceur sur [connect.capturs-systems.com](https://connect.capturs-systems.com) dans la rubrique “Balises > Mes Balises”.

 Aktivieren Sie den Tracker auf [connect.capturs-systems.com](https://connect.capturs-systems.com) im Bereich "Geräte > Meine Geräte".

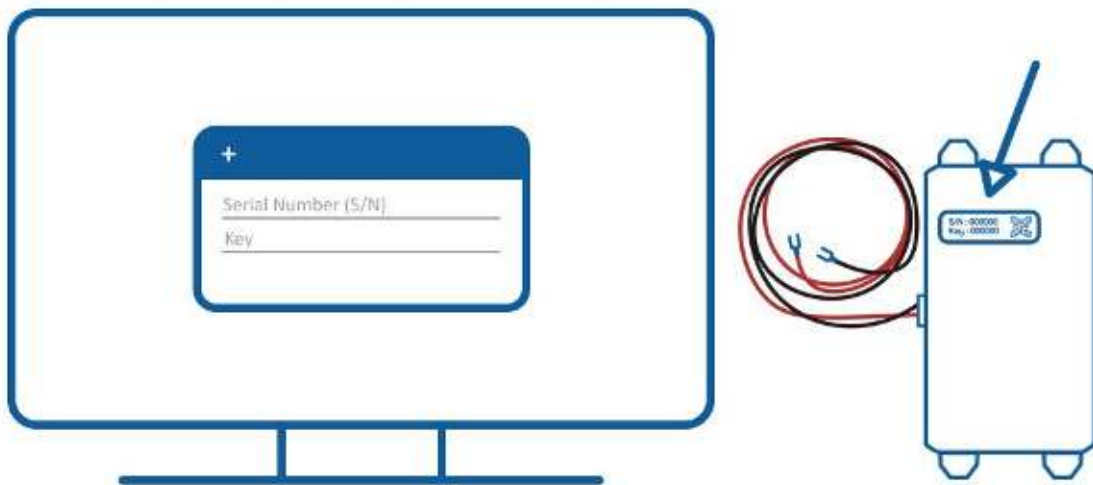



2)  Slightly loosen the nuts on the + and - terminals of your vehicle's battery so that you can connect the GPS tracker wires to the corresponding terminals.

 Dévissez légèrement les écrous situés aux bornes + et - de la batterie de votre véhicule afin de pouvoir connecter les câbles du traceurs GPS aux bornes correspondantes.

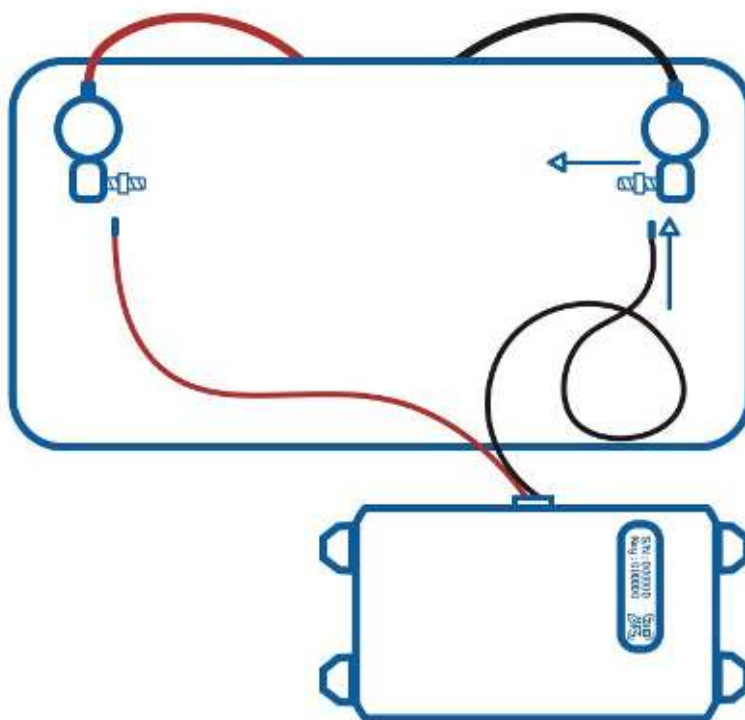
 Lösen Sie die Muttern an den + und - Polen der Fahrzeugbatterie leicht, damit Sie die Kabel des GPS-Trackers an die entsprechenden Klemmen anschließen können.





- 3)  Screw the nuts on the + and - terminals of your vehicle's battery when you have connected the GPS tracker. Using the double-sided tape provided, stick the GPS tracker face up (LED and label visible).

 Vissez les écrous situés aux bornes + et - de la batterie de votre véhicule lorsque vous avez branché le traceur GPS. A l'aide du double-face fourni, collez le traceur GPS la face avant vers le ciel (LED et étiquette visibles).

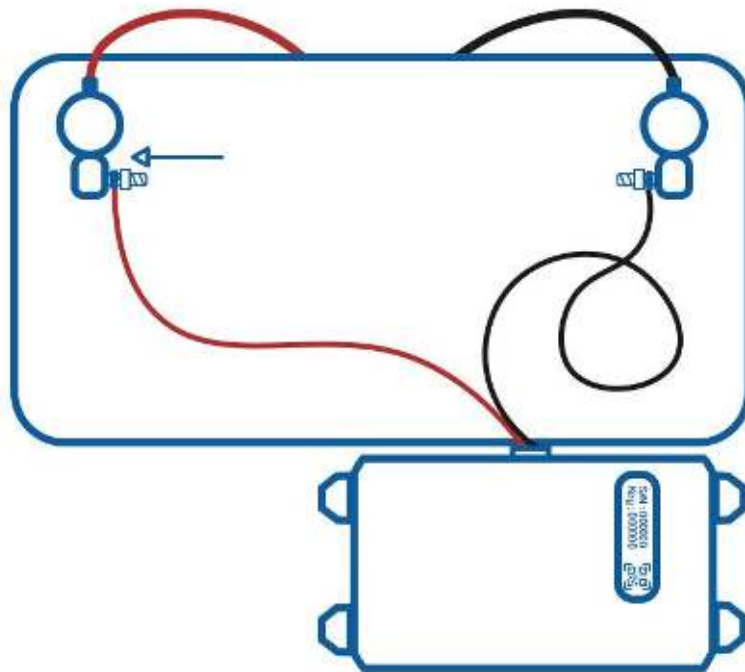
 Schrauben Sie die Muttern an den + und - Polen der Batterie Ihres Fahrzeugs auf, wenn Sie den GPS-Tracker angeschlossen haben. Kleben Sie den GPS-Tracker mithilfe des mitgelieferten doppelseitigen Klebebands mit der Vorderseite zum Himmel (LED und Etikett sind sichtbar).



- 7)  The tracker is switched on when the LED is flashing ([more about the flashing LEDs](#)).
-  Le traceur est allumé lorsque la LED clignote ([en savoir plus sur le clignotement des LEDs](#)).
-  Der Tracker ist eingeschaltet, wenn die LED blinkt ([mehr über das Blinken der LEDs](#)).